

Excavation Work

Code of Practice

December 2012
CPI07

This code of practice has been approved by the Tasmanian Minister for Workplace Relations under section 274 of the *Work Health and Safety Act 2012* and commences on 1 January 2013.

This code of practice is based on a national model code of practice developed by Safe Work Australia as part of the harmonisation of work health and safety laws under the Council of Australian Governments' *Inter-governmental Agreement for Regulatory and Operational Reform in Occupational Health and Safety*.

Safe Work Australia is an Australian Government statutory agency established in 2009. Safe Work Australia consists of representatives of the Commonwealth, state and territory governments, the Australian Council of Trade Unions, the Australian Chamber of Commerce and Industry and the Australian Industry Group.

Safe Work Australia works with the Commonwealth, state and territory governments to improve work health and safety and workers' compensation arrangements. Safe Work Australia is a national policy body, not a regulator of work health and safety. The Commonwealth, states and territories have responsibility for regulating and enforcing work health and safety laws in their jurisdiction.



Creative Commons

Except for the Safe Work Australia logo, this copyright work is licensed under a Creative Commons Attribution-Noncommercial 3.0 Australia licence.

[Creative Commons Attribution-Noncommercial 3.0 Australia licence information](#)

In essence, you are free to copy, communicate and adapt the work for non commercial purposes, as long as you attribute the work to Safe Work Australia and abide by the other licence terms.

Table of Contents

FOREWORD	4
SCOPE AND APPLICATION	4
1 INTRODUCTION	5
1.1 What is excavation work?	5
1.2 Who has health and safety duties in relation to excavation work?	5
1.3 What is required to manage risks associated with excavation work?	6
2 THE RISK MANAGEMENT PROCESS	8
2.1 Identifying the hazards	8
2.2 Assessing the risks	8
2.3 Controlling the risks	9
2.4 Reviewing control measures	10
3 PLANNING THE EXCAVATION WORK	11
3.1 Principal contractor	11
3.2 Designers	12
3.3 Safe Work Method Statements	12
3.4 Adjacent buildings or structures	13
3.5 Essential services	13
3.6 Securing the work area	14
3.7 Emergency plan	14
4 CONTROLLING RISKS IN EXCAVATION WORK	15
4.1 Excavated material and loads near excavations	15
4.2 Plant and equipment	17
4.3 Powered mobile plant	18
4.4 Falls	21
4.5 Using explosives	22
4.6 Atmospheric conditions and ventilation	22
4.7 Manual work	23
4.8 Information, training, instruction and supervision	24
5 EXCAVATION METHODS	25
5.1 Trenching	25
5.2 Tunnelling	25
5.3 Shafts	27
6 PREVENTING GROUND COLLAPSE	29
6.1 Benching and battering	31
6.2 Shoring	32
6.3 Removal of shoring supports	39
6.4 Shields and boxes	40
6.5 Other ground support methods	41
6.6 Regular inspection	41
APPENDIX A – DEFINITIONS	42

FOREWORD

This Code of Practice for managing health and safety risks associated with excavation work is an approved code of practice under section 274 of the *Work Health and Safety Act* (the WHS Act).

An approved code of practice is a practical guide to achieving the standards of health, safety and welfare required under the WHS Act and the *Work Health and Safety Regulations* (the WHS Regulations).

A code of practice applies to anyone who has a duty of care in the circumstances described in the code. In most cases, following an approved code of practice would achieve compliance with the health and safety duties in the WHS Act, in relation to the subject matter of the code. Like regulations, codes of practice deal with particular issues and do not cover all hazards or risks that may arise. The health and safety duties require duty holders to consider all risks associated with work, not only those for which regulations and codes of practice exist.

Codes of practice are admissible in court proceedings under the WHS Act and Regulations. Courts may regard a code of practice as evidence of what is known about a hazard, risk or control and may rely on the code in determining what is reasonably practicable in the circumstances to which the code relates.

Compliance with the WHS Act and Regulations may be achieved by following another method, such as a technical or an industry standard, if it provides an equivalent or higher standard of work health and safety than the code.

An inspector may refer to an approved code of practice when issuing an improvement or prohibition notice.

This Code of Practice has been developed by Safe Work Australia as a model code of practice under the Council of Australian Governments' *Inter-Governmental Agreement for Regulatory and Operational Reform in Occupational Health and Safety* for adoption by the Commonwealth, state and territory governments.

SCOPE AND APPLICATION

This Code provides practical guidance for persons conducting a business or undertaking on how to manage the health and safety risks associated with excavation work. This Code applies to all types of excavation work, including bulk excavations more than 1.5 metres deep, trenches, shafts and tunnels.

The guidance in this Code is relevant to excavation contractors as well as persons conducting a business or undertaking who have management or control of workplaces where excavation work is carried out, such as principal contractors.

Persons who have duties in relation to excavation work should also refer to the *Code of Practice: Construction Work*.

How to use this code of practice

In providing guidance, the word 'should' is used in this Code to indicate a recommended course of action, while 'may' is used to indicate an optional course of action.

This Code also includes various references to provisions of the WHS Act and Regulations which set out the legal requirements. These references are not exhaustive. The words 'must', 'requires' or 'mandatory' indicate that a legal requirement exists and must be complied with.

1 INTRODUCTION

Excavation failures are particularly dangerous because they may occur quickly, limiting the ability of workers (and in some cases others in the vicinity) to escape especially if the collapse is extensive.

The speed of an excavation collapse increases the risk associated with this type of work and the consequences are significant as the falling earth can bury or crush any person in its path. This can result in death by suffocation or internal crush injuries.

1.1 What is excavation work?

Excavation work generally means work involving the removal of soil or rock from a site to form an open face, hole or cavity using tools, machinery or explosives.

A person conducting a business or undertaking must manage risks associated with all kinds of excavations at the workplace, no matter how deep.

Specific duties apply in relation to the higher-risk excavations such as trenches, shafts and tunnels. However, these requirements do not apply to a mine, a bore to which a relevant water law applies or a trench used as a place of interment.

Any construction work (including any work connected with an 'excavation') that is carried out in or near:

- a shaft or trench with an excavated depth of greater than 1.5 metres, or
- a tunnel

is considered to be 'high risk construction work' for which a Safe Work Method Statement (SWMS) must be prepared.

Further guidance on the duties related to high risk construction work and SWMS is available in the *Code of Practice: Construction Work*.

Other key terms relating to excavation work are listed in Appendix A.

1.2 Who has health and safety duties in relation to excavation work?

A **person conducting a business or undertaking** has the primary duty to ensure, so far as is reasonably practicable, that workers and other persons are not exposed to health and safety risks arising from the business or undertaking.

The WHS Regulations include specific obligations for a person conducting a business or undertaking to manage the risks associated with excavation work, including trenches.

A person conducting a business or undertaking who has management or control of a workplace where excavation work is being carried out must take all reasonable steps to obtain current underground essential services information relating to the part of a workplace where the excavation work is being carried out and areas adjacent to it before directing or allowing the excavation to commence. This information must be provided to any person engaged to carry out excavation work.

For the purpose of this Code, the person conducting a business or undertaking who carries out the excavation work is sometimes referred to as the 'excavation contractor'.

A **principal contractor** for a construction project (i.e. where the cost of the construction work is \$250 000 or more) has additional duties under the WHS Regulations (refer to section 3.1 of this Code).

Designers of structures must ensure, so far as is reasonably practicable, that the structure is without risks to health and safety, when used for a purpose for which it was designed. Designers

must give the person who commissioned the design a written safety report that specifies the hazards relating to the design of the structure (refer to section 3.2 of this Code).

Officers, such as company directors, have a duty to exercise due diligence to ensure that the business or undertaking complies with the WHS Act and Regulations. This includes taking reasonable steps to ensure that the business or undertaking has and uses appropriate resources and processes to eliminate or minimise risks that arise from the excavation work.

Workers have a duty to take reasonable care for their own health and safety and that they do not adversely affect the health and safety of other persons. Workers must comply with any reasonable instruction and cooperate with any reasonable policy or procedure relating to health and safety at the workplace.

1.3 What is required to manage risks associated with excavation work?

Regulation 305 A person conducting a business or undertaking must manage risks to health and safety associated with excavation work.

Regulation 34-38 In order to manage risks under the WHS Regulations, a duty holder must:

- identify reasonably foreseeable hazards that could give rise to the risk
- eliminate the risk so far as is reasonably practicable
- if it is not reasonably practicable to eliminate the risk – minimise the risk so far as is reasonably practicable by implementing control measures in accordance with the hierarchy of control
- maintain the implemented control measure so that it remains effective
- review, and if necessary revise control measures so as to maintain, so far as is reasonably practicable, a work environment that is without risks to health and safety.

This Code provides guidance on managing the risks associated with excavation work by following a systematic process that involves:

- identifying hazards
- if necessary, assessing the risks associated with these hazards
- implementing control measures, and
- maintaining and reviewing the effectiveness of control measures.

Guidance on the general risk management process is available in the *Code of Practice: How to Manage Work Health and Safety Risks*.

Consulting your workers

Section 47 A person conducting a business or undertaking must consult, so far as is reasonably practicable, with workers who carry out work for them and who are (or are likely to be) directly affected by a work health and safety matter.

Section 48 If the workers are represented by a health and safety representative, the consultation must involve that representative.

Consultation with workers and their health and safety representatives is required at every step of the risk management process. In many cases, decisions about construction work and projects are made prior to engaging workers, therefore, it may not be possible to consult with workers in these early stages. However, it is important to consult with them as the excavation work progresses.

Consulting, co-operating and co-ordinating activities with other duty holders

Section 46 A person conducting a business or undertaking must consult, co-operate and co-ordinate activities with all other persons who have a work health or safety duty in relation to the same matter, so far as is reasonably practicable.

A construction workplace will often be shared by various persons conducting a business or undertaking, such as civil engineers and contractors. Persons with overlapping duties should exchange information about the risks associated with the excavation work including any traffic and plant movements near the excavation area. They should work together in a cooperative and coordinated way so that all risks are eliminated or minimised so far as is reasonably practicable.

Further guidance on consultation is available in the *Code of Practice: Work Health and Safety Consultation, Co-operation and Co-ordination*.

2 THE RISK MANAGEMENT PROCESS

Regulation 305 A person conducting a business or undertaking must manage risks to health and safety associated with excavation work before the work commences, including the risk of:

- a person falling into an excavation
- a person being trapped by the collapse of an excavation
- a person working in an excavation being struck by a falling thing
- a person working in an excavation being exposed to an airborne contaminant.

To manage the risks, all relevant matters must be considered including:

- the nature of the excavation
- the nature of the excavation work, including the range of possible methods of carrying out the work
- the means of entry into and exit from the excavation (if applicable).

2.1 Identifying the hazards

The first step in the risk management process is to identify the hazards associated with excavation work. Examples of excavation specific hazards include:

- underground essential services - including gas, water, sewerage, telecommunications, electricity, chemicals and fuel or refrigerant in pipes or lines. Information about the location of these and other underground services, such as drainage pipes, soak wells and storage tanks, in and adjacent to the workplace, must be established before directing or allowing excavation work to commence
- the fall or dislodgement of earth or rock
- falls from one level to another
- falling objects
- inappropriate placement of excavated materials, plant or other loads
- the instability of any adjoining structure caused by the excavation
- any previous disturbance of the ground including previous excavation
- the instability of the excavation due to persons or plant working adjacent to the excavation
- the presence of or possible inrush of water or other liquid
- hazardous manual tasks
- hazardous chemicals (e.g. these may be present in the soil where excavation work is to be carried out)
- hazardous atmosphere in an excavation (e.g. using Methyl Ethyl Ketone (MEK) solvent for PVC pipes in poorly ventilated trenches)
- vibration and hazardous noise
- overhead essential services (powerlines) and ground mounted essential services (transformers, gas and water meters).

2.2 Assessing the risks

Under the WHS Regulations, a risk assessment is not mandatory for excavation work however it is required for specific situations, for example when working with asbestos. In many circumstances a risk assessment will assist in determining the control measures that should be implemented. It will help to:

- identify which workers are at risk
- determine what sources and processes are causing that risk
- identify if and what kind of control measures should be implemented
- check the effectiveness of existing control measures.

When assessing the risks associated with excavation work you should consider things such as:

- local site conditions, including access, ground slope, adjacent buildings and structures, water courses (including underground) and trees
- depth of the excavation
- soil properties, including variable soil types, stability, shear strength, cohesion, presence of ground water, effect of exposure to the elements
- fractures or faults in rocks, including joints, bedding planes, dip and strike directions and angles, clay seams
- any specialised plant or work methods required (e.g. ground support)
- the method(s) of transport, haul routes and disposal
- what exposures might occur, such as to noise, ultra violet rays or hazardous chemicals
- the number of people involved
- the possibility of unauthorised access to the work area
- local weather conditions
- the length of time that the excavation will be open.

2.3 Controlling the risks

The hierarchy of control measures

Some control measures are more effective than others. Control measures can be ranked from the highest level of protection and reliability to the lowest. This ranking is known as the *hierarchy of control*.

You must always aim to *eliminate a hazard*, which is the most effective control. If this is not reasonably practicable, you must minimise the risk by one or a combination of the following:

- *Substitution* – for example, using an excavator with a rock breaker rather than manual method
- *Isolation* – for example, using concrete barriers to separate pedestrians and powered mobile plant to reduce the risk of collision
- *Engineering Controls* – for example benching, battering or shoring the sides of the excavation to reduce the risk of ground collapse.

If risk remains, it must be minimised by implementing *administrative controls*, so far as is reasonably practicable, for example by installing warning signs near the excavation.

Any remaining risk must be minimised with suitable *personal protective equipment* (PPE), such as providing workers with hard hats, hearing protectors and high visibility vests.

Administrative control measures and PPE rely on human behaviour and supervision and used on their own tend to be the least effective in minimising risks.

Factors that should be considered when choosing suitable control measures include:

- excavating plant - when quantities are large, it may be effective to use different types of plant for the various materials to be excavated
- stockpiling arrangements - another site may need to be found for temporary stockpiling of materials
- material placement - the methods and plant used for excavating, transporting and compacting the material should be evaluated
- dewatering equipment, if required, and the system to be used
- transport of the excavated material - the type of plant used, the length of haul, the nature of the haul route, and the conditions of tipping and/or spreading.

Chapters 4-6 of this Code provide information on control measures for excavation work.

2.4 Reviewing control measures

The control measures that are put in place to protect health and safety should be regularly reviewed to make sure they are effective.

Regulation 39 You must review your control measures and, if necessary, revise them:

- when the control measure is not effective in controlling the risk
- before a change at the workplace that is likely to give rise to a new or different health and safety risk that the control measure may not effectively control
- if a new hazard or risk is identified
- if the results of consultation indicate that a review is necessary, or
- if a health and safety representative requests a review.

Common review methods include workplace inspection, consultation, testing and analysing records and data. When reviewing control measures, a SWMS must also be reviewed and revised where necessary.

If problems are found, go back through the risk management steps, review your information and make further decisions about control measures.

3 PLANNING THE EXCAVATION WORK

Excavation work should be carefully planned before work starts so it can be carried out safely. Planning involves identifying the hazards, assessing the risks and determining appropriate control measures in consultation with all relevant persons involved in the work, including the principal contractor, excavation contractor, designers and mobile plant operators. Structural or geotechnical engineers may also need to be consulted at this stage.

Consultation should include discussions on the:

- nature and/or condition of the ground and/or working environment
- weather conditions
- nature of the work and other activities that may affect health and safety
- static and dynamic loads near the excavation
- interaction with other trades
- site access
- SWMS
- management of surrounding vehicular traffic and ground vibration
- type of equipment used for excavation work
- public safety
- existing services and their location
- the length of time the excavation is to remain open
- provision of adequate facilities
- procedures to deal with emergencies.

Further information on amenities and emergencies is available in the Code of Practice: *Managing the Work Environment and Facilities*.

3.1 Principal contractor

Where the value of construction work is \$250 000 or more, the construction work is considered a 'construction project' for which additional duties apply to the principal contractor. There can only be one principal contractor for a construction project and this will be either the person commissioning the construction work or a person appointed as the principal contractor by the person commissioning the construction work.

The principal contractor has a range of duties in relation to a construction project including:

- preparing and reviewing a WHS management plan
- obtaining SWMS before any high risk construction work commences
- putting in place arrangements to manage the work environment including falls, facilities, first aid, an emergency plan and traffic management
- installing signs showing the principal contractor's name, contact details and location of any site office
- securing the construction workplace.

Where significant excavation work is being carried out and building works have not commenced the person who commissions the construction work may appoint the excavation contractor as the principal contractor for the site preparation phase of the project and then replace them with a building expert after this phase is completed. If the excavation contractor is appointed as the principal contractor the contractor must comply with all principal contractor duties while undertaking this role.

For further guidance on how to calculate the cost of construction work and on principal contractor duties refer to the *Code of Practice: Construction Work*.

3.2 Designers

Section 22 Designers must ensure, so far as is reasonably practicable, that the structure is designed to be without risks to the health and safety of persons who construct the structure at a workplace.

Regulation 295 The designer of a structure or any part of a structure that is to be constructed must give the person conducting a business or undertaking who commissioned the design a written report that specifies the hazards associated with the design of the structure that, so far as the designer is reasonably aware:

- create a risk to the health or safety of persons who are to carry out construction work on the structure or part, and
- are associated only with the particular design and not with other designs of the same type of structure.

Designers of structures should consider possible excavation work methods and health and safety control measures when producing any final design documents and the safety report for the structure.

A person commissioning the construction work must consult, so far as is reasonably practicable, with the designer of the whole or any part of the structure about eliminating and controlling risks. If the person commissioning the construction work did not commission the design of the construction project, they must take all reasonable steps to obtain the designer's safety report.

Where there is a principal contractor, the person commissioning the construction work must give the principal contractor any information they have about the hazards and risks associated with the work.

For further guidance on the duties of designers refer to the *Code of Practice: Safe Design of Structures*.

3.3 Safe Work Method Statements

If the excavation work is or involves high risk construction work, a person conducting a business or undertaking must prepare a SWMS before the high risk construction work starts. The SWMS must:

- identify the type of high risk construction work being done
- specify the health and safety hazards and risks arising from that work
- describe how the risks will be controlled
- describe how the control measures will be implemented, monitored and reviewed
- be developed in consultation with workers and their representatives who are carrying out the high risk construction work.

In some circumstances one SWMS can be prepared to cover more than one high risk construction work activity being carried out at the workplace by contractors and/or subcontractors. For example, where there is:

- a risk of a person falling more than 2 metres
- a trench with an excavated depth greater than 1.5 metres.

In this case, the contractors or subcontractors can consult and cooperate to prepare one SWMS. Alternatively they can prepare separate SWMS. If they choose to do this they must consult with each other to ensure all SWMS are consistent and they are not creating unintended additional risks at the workplace.

Further guidance on SWMS and an example SWMS template is available in the *Code of Practice: Construction Work*.

3.4 Adjacent buildings or structures

Excavation work may seriously affect the security or stability of any part of a structure at or adjacent to the location of the proposed excavation which can lead to structural failure or collapse. Excavation work must not commence until steps are taken to prevent the collapse or partial collapse of any potentially affected building or structure.

Any excavation that is below the level of the footing of any structure including retaining walls that could affect the stability of the structure must be assessed by a competent person and secured by a suitable ground support system which has been designed by a competent person. Suitable supports to brace the structure may also be required and should be identified by a competent person.

It is also important that other buildings in and around the excavation site are not adversely affected by vibration or concussion during the excavation work. Special precautions may need to be taken in the vicinity of hospitals and other buildings containing equipment sensitive to shock and vibration.

Excavation work must be carried out in a way that does not cause flooding or water penetration to any adjacent building.

3.5 Essential services

Essential services include the supply of gas, water, sewerage, telecommunications, electricity, chemicals, fuel and refrigerant in pipes or lines. The principal contractor must manage the risks associated with essential services at the workplace.

Specific control measures must be implemented before using excavators or other earthmoving machinery near overhead electric lines. The relevant authority should be consulted regarding approach distances and appropriate control measures implemented to prevent any part of the plant or any load carried on it from coming too close or contacting overhead electric lines.

Underground essential services

Regulation 304 A person with management or control of the workplace must, before directing or allowing work to commence, take all reasonable steps to obtain current underground essential services information about the areas at the workplace where the excavation work is to be carried out. They must also obtain information about underground essential services in areas adjacent to the site of excavation and have regard for all of the information.

Information on the location of underground services may be obtained by contacting the Dial Before You Dig organisation in your state or territory. Any underground service plans that are obtained including information on underground essential services must be provided to the principal contractor and/or the excavation contractor. Other relevant parties including any subcontractors and plant operators carrying out the excavation work should also be provided with information about essential services and other plans so the information is considered when planning all work in the area.

Underground essential services information obtained must be:

- made available to any worker, principal contractor and subcontractors
- readily available for inspection, as required under the WHS Act, and
- retained until the excavation work is completed or, if there is a notifiable incident relating to the excavation work, 2 years after the incident occurs.

Available information about existing underground essential services may not be accurate. Therefore it is important that excavation methods include an initial examination of the area to be excavated, for example, sampling the area by exposing a short section of underground services usually using water pressure and a vacuum system to excavate or 'pothole' the area.

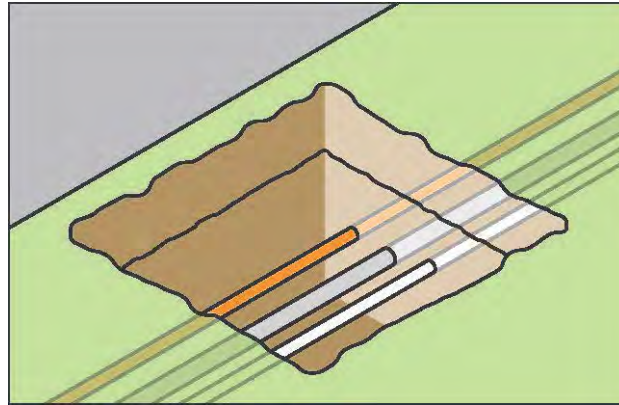

Figure 1: Underground essential services exposed by 'potholing'

Further guidance on underground essential services and how to locate them is available in the *Code of Practice: Construction Work*.

3.6 Securing the work area

Regulation 306 A person conducting a business or undertaking who proposes to excavate a trench at least 1.5 m deep, must ensure, so far as is reasonably practicable, that the work area is secured from unauthorised access (including inadvertent entry).

In securing the trench or excavation, you must consider:

- risks to health and safety arising from unauthorised access to the work area, and
- the likelihood of unauthorised access occurring.

This requirement aims to protect other workers on site who may be at risk by restricting access to the excavation area. It applies in addition to the duty that the person with management or control of the construction site has to ensure, so far as is reasonably practicable, that the site is secured from unauthorised access from members of the public, for example when the site is near schools, parks, shops or other public places.

Further information on site security and site access is available in the *Code of Practice: Construction Work*.

3.7 Emergency plan

Regulation 43 A person conducting a business or undertaking must ensure that an emergency plan is prepared for the workplace.

The excavation contractor must ensure that the emergency plan deals with unexpected incidents, such as ground slip, flooding, gas leaks and the rescue of workers from an excavation.

To ensure a co-ordinated response to an emergency, the plan should be incorporated as part of the broader construction project emergency plan prepared by the principal contractor.

4 CONTROLLING RISKS IN EXCAVATION WORK

The following table lists common hazards associated with excavation work and examples of control measures:

Potential hazards	Examples of control measures
Ground collapse	The use of benching or the installation of ground support (e.g. shoring)
Water inrush	Pumps or other dewatering systems to remove water and prevent build-up
Falls	Ramps, steps or other appropriate access into the excavation
Hazardous manual tasks	Rotating tasks between workers
Airborne contaminants	Mechanical ventilation to remove airborne contaminants
Buried contaminants (e.g. asbestos)	Training to identify buried contaminants and what action to take
Underground services	Obtain information from the relevant authorities on the location of underground services.

4.1 Excavated material and loads near excavations

Mechanical plant, vehicles, storage of materials (including excavated material) or any other heavy loads should not be located in the 'zone of influence' of an excavation. The ground support system installed has been designed by a competent person, for example, a geotechnical engineer, to carry such loads.

The zone of influence will depend on the ground conditions. It is the zone in which there may be an influence on the excavation, including possible ground collapse (see Figure 2).

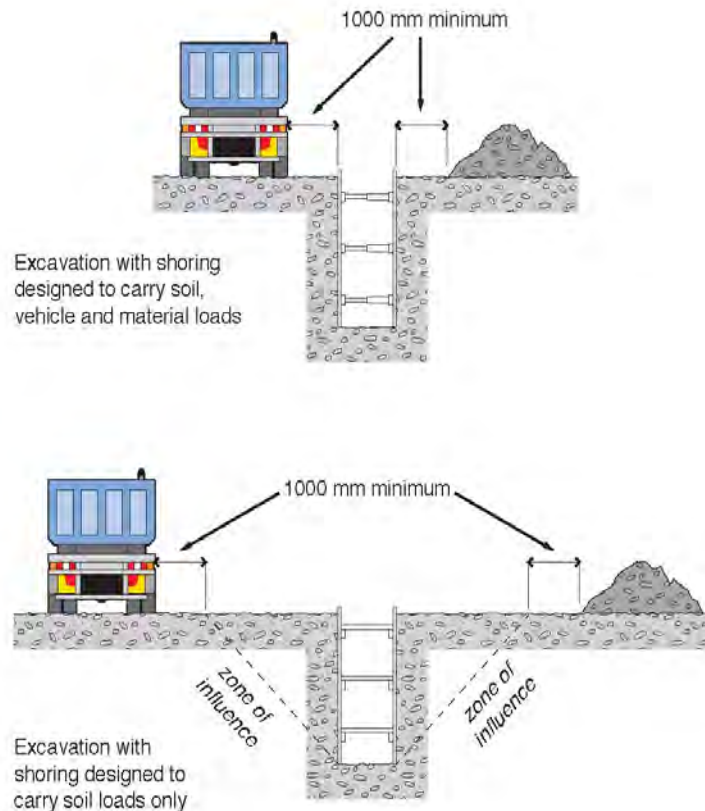

Figure 2: Excavated material and loads near excavations

Figure 2 shows an example of:

- an excavation with shoring that has been designed to carry vehicle and material loads – this may be required where there is limited space around the excavation for vehicle movement and /or material storage
- an excavation with shoring that has been designed only to carry the load of the excavated faces and the related zone of influence.

Any material will add a load to the area where it is placed. It is important that materials are not placed or stacked near the edge of any excavation as this would put persons working in the excavation at risk. For example, the placement of material near the edge of an excavation may cause a collapse of the side of the excavation.

To reduce the risk of ground collapse, excavated or loose material should be stored away from the excavation. Excavated material should be placed outside the zone of influence. Alternatively, a ground support system should be designed and installed to carry the additional loads, including any ground water pressures, saturated soil conditions and saturated materials.

If excavating in sloping ground decide which side of the excavation to place the excavated material. Things to consider include:

- ground conditions
- access to the excavation
- existing underground services
- the need for earthmoving machinery or vehicles to work or move along beside the excavation
- service installation and backfilling requirements

- any manual work being undertaken in the excavation.

Placing material on the lower side of the excavation will reduce the effective height of the excavation (see Figure 3) and the risk of material falling or being washed into the excavation.

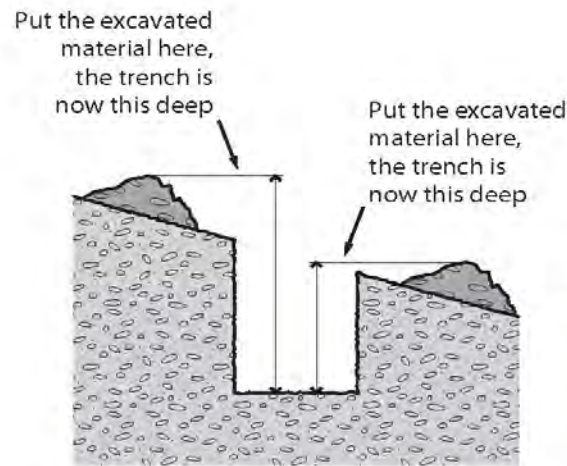

Figure 3: Excavated material impact on effective excavation depth

Care should be taken to ensure that material placed on the high side of the excavation does not increase the risk of ground collapse, or flooding by ponding or holding back runoff water. Excavated material should be placed so that it channels rainwater and other run-off water away from the excavation.

When a trench is being excavated beside an old service line, the excavated material should be placed on the side opposite the old service line to prevent excessive loading on previously weakened ground.

If excavated material is placed close to a trench due to obstructions such as fences, buildings or trees, the weight of the excavated material may overload the sides of a trench. In this case, the ground support system should be strengthened at these locations and barriers such as toeboards may need to be provided to prevent the material falling into the excavation.

Different soils when dumped in heaps, will assume a characteristic shape and settle naturally at different slopes. The angle which a sloping face of loose earth makes with the horizontal is sometimes referred to as the angle of repose. However, it is poor practice to relate the safe slope of an excavation to the angle of repose, even though the safe slope may be similar in some types of soil to the angle of repose.

4.2 Plant and equipment

Excavation work cannot be carried out safely unless the plant being used is appropriate for the work and maintained in good condition. A range of plant and equipment may be used for excavation work including:

- powered mobile plant (see section 4.3)
- air compressors
- electric generators
- jack hammers
- hydraulic jacks

- oxy-acetylene (gas cutting/welding)
- scaffolding
- ladders
- many types of handheld plant such as shovels, picks, hammers, hydraulic jacks and pinch/lever bars.

You should ensure:

- plant is used and operated by a competent person
- that appropriate guards and operator protective devices are fitted
- that the safe working load is displayed and any load measurement devices are operating correctly
- plant is maintained in accordance with the manufacturer/supplier's instructions or relevant Australian Standards.

Further general guidance on plant can be found in the *Code of Practice: Managing Risks of Plant in the Workplace*.

Lasers

Lasers must be designed, constructed and installed so that no person is exposed to accidental irradiation. Lasers that are capable of producing hazardous diffuse reflections or that may constitute a fire hazard, being laser classes 3B and 4, must not be used in construction work.

Any worker operating lasers must be trained in the use of the equipment. Further information on the safe use of lasers is available in AS 2397: *Safe use of lasers in the building and construction industry*.

4.3 Powered mobile plant

A wide range of powered mobile plant, including earthmoving machinery, may be used for excavation work. To select plant that is suitable for the task, you should consider:

- site access and restrictions
- site hazards such as overhead powerlines and underground services
- the ground conditions
- the type and depth of excavation
- the volume of material to be excavated and transported
- where the excavated material is to be located and/or stored.

A high risk work licence is required to operate some types of powered mobile plant. However, in most cases earthmoving machinery does not require a licensed operator if it is being used for the purpose for which it was originally designed. Earthmoving machinery operators must be able to demonstrate they are competent to operate the specific type of plant being used and any attachments fitted to the plant.

Traffic management arrangements must be implemented at the workplace when powered mobile plant is to be used for excavation work to prevent collision with pedestrians or other mobile plant.

Earthmoving machinery

Bulldozers and scrapers are often used to prepare a work area for further specific excavation.

Bulldozers typically excavate and move large amounts of material short distances. Bulldozers can be equipped with hydraulically operated rippers at the back of the machine which are capable of loosening the hardest of sedimentary rocks. This material may then be bulldozed away. This method frequently proves more economical than drilling and blasting softer rock.

Self-propelled rubber tyred scrapers enable very large quantities of material to be excavated and hauled economically over long distances at relatively high speed. Because of the large potential

output and speeds of modern scrapers, careful attention should be given to job layout, haul roads, vehicle pathways and overall traffic management to achieve a healthy and safe workplace.

Temporary haul roads should be well constructed and maintained to enable plant operators to complete the work safely.

Large earthmoving machinery such as bulldozers should not operate close to an overhang or a deep excavation as the weight may collapse the sides. Equipment should always approach embankments or trenches from across the line of a trench rather than parallel to it.

Excavation work exceeding 1.5 metres deep is typically done by excavators or specialised plant such as tunnelling machines and raise-bores. Most of these types of plant have an element of mobility, although tunnelling machines typically have restricted movement.

Other plant used in excavation work includes backhoes, rubber tyred loaders, skid steer loaders (e.g. bobcat), trench diggers, graders and tip trucks.

Blind spots

Operators of powered mobile plant can often have severely restricted visibility of ground workers or nearby pedestrians, particularly those close to the plant. Figure 4 shows some of the blind spots for operators of typical excavation equipment.

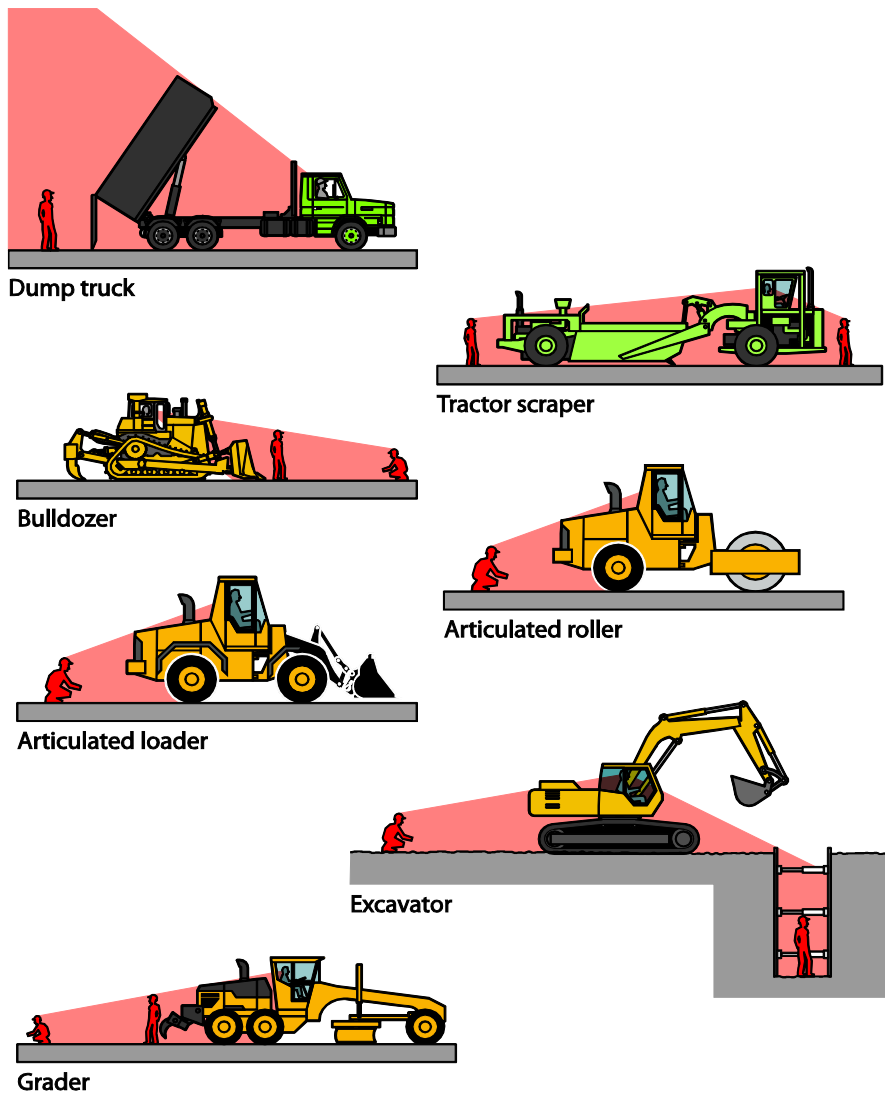

Figure 4: Mobile plant operator blind spots

Powered mobile plant operating near ground personnel or other powered mobile plant should be equipped with warning devices (e.g. reversing alarm and a revolving light).

An effective system of communication based on two way acknowledgement between mobile plant operators and ground workers should be established before work commences. Relevant workers should also be trained in the procedures involved prior to the work commencing. The system should stop ground workers from approaching mobile plant until the operator has agreed to their request to approach. Similarly the system should stop operators from moving plant closer than a set distance from ground workers until the operator has been advised by ground workers that they are aware of the proposed movement.

Mobile plant operators and ground workers should be made familiar with the blind spots of particular items of plant being used. Induction training programs should emphasise the dangers of workers working in close proximity to mobile plant, and adequate supervision should be provided.

Mobile plant operators and ground workers should be provided with and required to wear high-visibility clothing.

Operator protection

Powered mobile plant should be equipped with appropriate combination of operator protection devices, for example, enclosed cabin and seat belts, to prevent the ejection of the operator or the operator being struck by falling objects.

Any earthmoving machinery weighing more than 1500 kgs, not including attachments, and designed to have a seated operator must have an appropriate operator protective structure fitted. These are either in the form of roll-over protective structures (ROPS) or falling object protective structures (FOPS) or both, depending on the application.

Operating near excavations

Powered mobile plant should not operate or travel near the edge of an excavation unless the ground support system installed has been designed by a competent person to carry such loads. Physical barriers, such as wheel stoppers, can be one way of restricting plant movement near an excavation (see Figure 5).

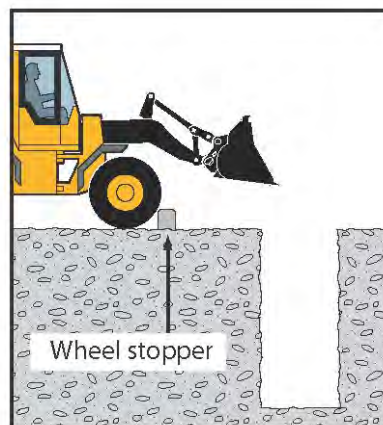

Figure 5: Preventing plant operation near excavations

Inspection and maintenance

Regular planned inspection and adequate maintenance must be carried out in accordance with the manufacturer's recommendations to ensure safe operation of mobile plant used on excavation work, whether leased, hired or owned. Both mechanical and electrical testing should be done. The following checks should also be carried out:

- daily pre-start checks by the plant operator on the general condition and maintenance of the plant
- regular inspections of the plant by a competent person in accordance with the manufacturer/supplier's specifications or relevant Australian Standards.

Any plant defects should be reported immediately to the person conducting business or undertaking. Where a defect is likely to pose an immediate risk to health and safety the plant should be removed from service until the defect is rectified.

Owners of plant should keep logbooks and inspection check sheets containing a full service and repair history. These records should include any reported defects, kept current and retained for the life of the plant. If the plant is sold, the records should form part of the documentation forwarded to the purchaser of the plant upon its sale.

4.4 Falls

Regulation 78 A person conducting a business or undertaking must manage the risk of a fall from one level to another that is reasonably likely to cause injury to the person or another person.

In managing the risks of falls, the WHS Regulations require the following specific control measures to be implemented where it is reasonably practicable to do so:

- carry out the work on solid construction that includes a safe means of access and egress
- if a fall risk cannot be eliminated, minimise the risk of fall by providing and maintaining a safe system of work including:
 - using fall prevention devices (e.g. temporary work platforms and guard rails) or
 - work positioning systems (e.g. industrial rope access systems), or
 - fall arrest systems such as catch platforms.

Control measures include:

- the support system itself, for example using trench box extensions or trench sheets longer than the trench depth (see Figure 6)
- installing guard rails or covers on trench shields (see Figure 7)
- inserting guard rails and toe boards into the ground immediately next to the supported excavation side
- installing landing platforms or scaffold towers inside deep excavations
- securing ladders to trench shields
- installing effective barriers or barricades
- providing clearly defined pedestrian detours
- provision of alternative access and egress points to the excavation for emergency use
- backfilling the excavation as work progresses.

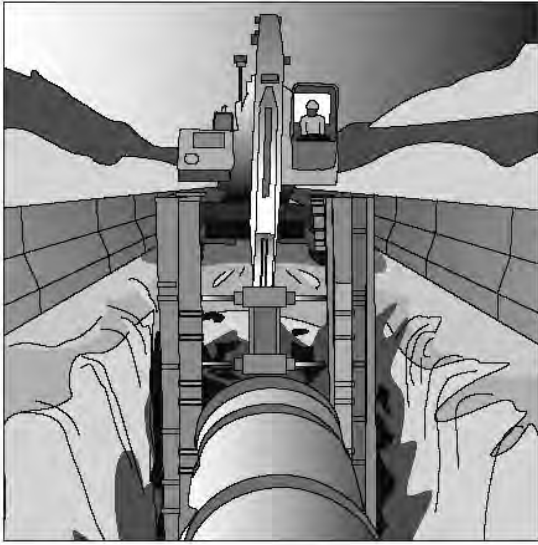

Figure 6: Extending trench shields above the excavation

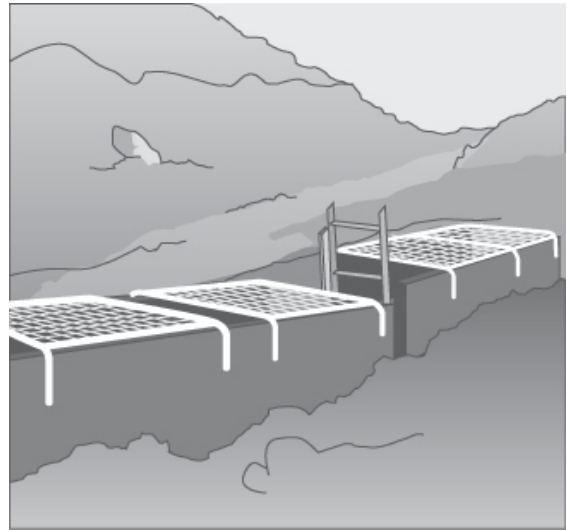

Figure 7: Steel mesh covers over trench shields

A SWMS must be prepared for excavation work that involves a risk of a person falling more than 2 metres.

Further guidance on controlling the risk of falls is available in the *Code of Practice: How to Prevent Falls at Workplaces*.

4.5 Using explosives

Construction work that involves the use of explosives is defined by the WHS Regulations as high risk construction work and a SWMS must be prepared before this work commences.

A competent person experienced in the controlled application of explosives for the purpose of carrying out the excavation work should be consulted before deciding whether explosives may be used for the excavation.

All possession, storage, handling and use of explosives must be carried out in compliance with the relevant dangerous substances/goods or explosives legislation applicable in your state or territory.

The transport of explosives must be in accordance with the *Australian Code for the Transport of Explosives by Road and Rail*.

Explosives must only be used by a competent person who is licensed in the use of explosives and has experience in the work to be undertaken. If explosives are used in excavation work, a licensed competent person must develop the blast management plan and be responsible for all aspects of the use of explosives.

For further information on the use of explosives for excavation work, refer to AS 2187.2: *Explosives – Storage and Use - Use of Explosives*

4.6 Atmospheric conditions and ventilation

The risk of atmospheric contamination through a build up of gases and fumes must be controlled in excavation work. Gases and fumes heavier than air can collect in tunnels and excavations for example: gases (such as sulphur dioxide), engine fumes (such as carbon monoxide and carbon dioxide) and leakage from gas bottles, fuel tanks, sewers, drains, gas pipes and LPG tanks.

Plant that uses a combustion engine (e.g. air compressors, electrical generators) should never be used in a confined excavation such as a trench if workers are in the trench. The build-up of exhaust gases in the excavation, particularly carbon monoxide, can cause death.

Ventilation systems help to maintain adequate oxygen levels and dilute flammable gases, fumes and certain dusts, such as coal and sulphide which can ignite if in its explosive limits. The use of mechanical ventilation also reduces dust, fumes, hazardous contaminants and can control air temperature and humidity.

The ventilation system should be designed by a competent person to provide adequate ventilation levels through the excavation (e.g. a tunnel) during construction. This might include additional localised extraction ventilation to deal with the production of dust, heat or fumes from the excavation process and the operation of large plant or other activities, such as plant maintenance. The design should allow for the installation of ventilation equipment or ducting as the excavation progresses to maintain adequate air supply to the working face.

Other methods of controlling the risks associated with atmospheric contamination include:

- pre-start checks of atmospheric conditions
- using gas monitors including workers' wearing personal monitors near their airways
- ensuring adequate ventilation (either natural or mechanical)
- working in pairs, with one person as a safety observer at the surface to monitor conditions
- ensuring familiarity with rescue procedures
- using PPE.

Further guidance on working in confined spaces is available in *Code of Practice: Confined Spaces*.

4.7 Manual work

Manual excavation methods are generally used for small, shallow excavations (e.g. less than 1.5 metres deep) in soft soils.

Regulation 60 A person conducting a business or undertaking must manage the risk of a musculoskeletal disorder associated with hazardous manual tasks.

When working in close proximity, workers should be kept sufficiently far apart to prevent injury from the use of picks or other hand tools. This applies particularly to work in trenches and small excavations.

Preparatory drilling activity and the use of hand drills may increase the risk of musculoskeletal disorders, including disorders associated with exposure to vibration. For further guidance on controlling the risks of musculoskeletal disorders, refer to the *Code of Practice: Hazardous Manual Tasks*.

4.8 Information, training, instruction and supervision

Section 19 A person conducting a business or undertaking must ensure, so far as is reasonably practicable, the provision of any information, training, instruction and supervision that is necessary to protect all persons from risks to their health and safety arising from the work carried out.

Regulation 39 A person conducting a business or undertaking must ensure that information, training and instruction provided to a worker is suitable and adequate having regard to:

- the nature of the work carried out by the worker
- the nature of the risks associated with the work at the time of the information, training and instruction, and
- the control measures implemented.

The training provided must be readily understandable by any person to whom it is provided.

Regulation 317 A person conducting a business or undertaking must not direct or allow a worker to carry out construction work unless the worker has successfully completed general construction induction training.

Training specific to the excavation work and to the site should also be provided to workers by a competent person. Workers operating certain types of plant at the workplace must possess a valid licence to operate that plant.

Workers in a supervisory role (for example, leading hand or foreman) should be experienced and trained in excavation work to ensure the work is carried out in accordance with SWMS.

Further information on general construction induction training and other training is available in Chapter 6 of the *Code of Practice: Construction Work*.

5 EXCAVATION METHODS

The nature of the excavation work being undertaken will affect the selection of an excavation method and a safe system of work. Careful consideration should be given to health and safety issues when planning the work where the excavation involves anything other than shallow trenching and small quantities of material.

5.1 Trenching

R.306 A person conducting a business or undertaking who proposes to excavate a trench at least 1.5m deep, must minimise the risk to any person arising from the collapse of the trench by ensuring that all sides of the trench are adequately supported by one or more of the following:

- shoring by shielding or other comparable means (for example, boxing)
- benching
- battering.

A combination of these control measures may be the most effective depending on the work environment and characteristics of the excavated material. In built up areas or streets the excavation may have to be fully or partly sheeted or supported to prevent collapse due to localised vehicle movement.

Where a worker enters a trench and there is a risk of engulfment, these control measures should be implemented regardless of the depth of the trench.

A report from a geotechnical engineer may be required to provide information on the stability and safety of a trench excavation. The report should include details of the soil conditions, any shoring or trench support requirements, dewatering requirements and any longer term effects on stability and safety of the excavation. A competent person (e.g. an engineer) should design any support systems or be involved in the selection of other ground collapse control measures, such as trench shields.

Shoring, benching and/or battering may not be required if written advice is received from a geotechnical engineer that all sides of the trench are safe from collapse. Any advice should state the period of time to which it applies and may be subject to a condition that specified natural occurrences may create a risk of collapse.

Preparation and excavation

Bulldozers, scrapers, excavators and other types of earthmoving equipment are commonly used for either preparing work areas prior to trenching or for the trenching work itself.

For some trench excavations manual work, such as trimming by hand, will be required. Trimming can often be accomplished from outside the trench by shovelling or pushing the material with a long handled tool or shovel to the bottom of the excavation where it can be picked up by the excavation plant. Risks associated with falls and working with powered mobile plant must be controlled.

5.2 Tunnelling

The nature of tunnelling work is complex and highly specialised, requiring high levels of engineering expertise during the planning, investigation, design and construction stages.

Design

Safe tunnel construction depends on adequate pre-construction engineering investigation of the ground and site and accurate interpretation of the information obtained. Designers should:

- obtain or be provided with all available relevant information
- be advised of any gaps in the information for planning and construction
- undertake or be involved in data acquisition for the site investigation program
- have on-site involvement during the engineering investigation.

The information obtained from the engineering investigation and the anticipated excavation methods should be considered in preparing a tunnel design. The design should include:

- details on the tunnel dimensions and allowable excavation tolerances
- temporary and final support and lining requirements for each location within the tunnel
- details of expected tunnel drive lengths and location of shafts
- any other requirements for the finished tunnel.

The design should also include information on the excavation methods and ground conditions considered in the design. This will allow the design to be reviewed if another excavation method is chosen or the ground conditions differ from that expected as the excavation proceeds.

The design also needs to take into account the construction methods that may be used to construct the tunnel so that a safe design for construction purposes is achieved.

Tunnelling hazards and risks

Common hazards and risks in tunnel construction generally relate to the confines of working underground including:

- tunnel stability – rock or earth falls and rock bursts
- changing ground conditions – strata and stress fluctuations
- limited space and access, with possible confined spaces involved
- air contamination or oxygen depletion
- fire or explosion
- the use of fixed and powered mobile plant
- the interaction of people and powered mobile plant
- temporary electrical supplies and circuits, including loss of power for lighting and ventilation
- compressed air use and high pressure hydraulics
- large scale materials and equipment handling
- overhead seepage, ground and process water
- uneven and wet or other slippery surfaces
- falls of people or objects
- contaminated groundwater
- ground gas and water in-rush
- noise
- vibration
- heat and humidity
- ground loss or settlement at surface level
- hazardous substances.

Control measures include:

- ground support, for example, tunnelling shields, mesh, rockbolts and shotcrete
- appropriate fall protection, for example temporary work platforms
- plant and vehicular traffic management systems
- regular plant maintenance
- pumps or dewatering systems to remove ground water
- mechanical ventilation to control airborne contaminants and air temperature/humidity
- dust extraction
- plant fitted with water scrubbers
- plant fitted with catalytic converters
- provision of breathing equipment when a hazardous atmosphere is present and cannot be effectively ventilated by external means.

Using ground support designed for the unique circumstances of the work is essential to control the risk of a collapse or tunnel support failure. All excavation for tunnelling should be supported.

5.3 Shafts

Shafts are often constructed to provide access or ventilation to a tunnel. Comparatively shallow shafts can be sunk for investigating or constructing foundations, dewatering or providing openings to underground facilities.

Shafts vary greatly in design and construction technique, depending on their purpose and the local conditions. They may be vertical or inclined, lined or unlined, various shapes, and excavated using various techniques.

Shaft sinking involves excavating a shaft from the top, with access and spoil removal from the top. Other construction methods include raise-boring, which is a method of constructing a shaft (or raise) where underground access has already been established. Raised bored shafts can be from the surface or from one horizon to another underground. The method can be remotely executed, not requiring people to enter the shaft.

Access to shaft openings should be controlled by using a secure cover that is lockable and accessible only by a designated persons. An alternative means is to use a suitable guard rail and toe-board with gate for access and supporting the sides by steel frames or sets of timber. In special cases support can also be provided by installing precast concrete or steel liners.

Shafts can have special features so design and construction advice should be obtained from a competent person (e.g. an engineer) before excavation and installation. In some cases, special ventilation facilities may be required.

Common hazards and risks involved in shaft construction include:

- shaft dimensions limiting work space, possibly including confined space work
- the potential for ground instability for lifting and removing spoil
- falls and falling objects, including fine material and water from the shaft wall
- hoisting equipment (e.g. winch, ropes and hooks)
- hoisting and winching people, materials, spoil and plant
- water inflow/inrush and dewatering
- airborne contaminants and ventilation
- confined space
- manual tasks
- hazardous materials
- fire or explosion
- inadequate communication systems
- mobile plant
- noise

- emergency exits.

Control measures include:

- stabilising the ground at the head of the shaft and removal of spoil
- continuously lining or supporting the shaft
- providing appropriate fall protection, for example temporary work platforms
- providing and maintaining appropriate hoisting equipment
- installing dewatering systems
- installing mechanical ventilation to control airborne contaminants and air temperature/humidity
- isolating access to moving parts of plant and equipment
- guiding the working platforms and material
- avoiding overfilling material kipples and cleaning kipples before lifting
- closing shaft doors before tipping
- cleaning the spillage off doors, stage and any steelwork.

Further guidance on confined spaces is available in the *Code of Practice: Confined Spaces*.

6 PREVENTING GROUND COLLAPSE

Ground collapse is one of the primary risks to be controlled in excavation work. Ground collapse can occur quickly and without warning, giving a worker virtually no time to escape, especially if the collapse is extensive. A buried worker is likely to die from suffocation before help arrives (e.g. either the head is buried, or the chest is so restricted by the weight of ground that the worker can no longer breathe).

Figure 8 shows a typical example of ground failure where material collapses onto a worker pinning them against the wall of a trench. Trench collapses of this nature can cause fatal injuries.

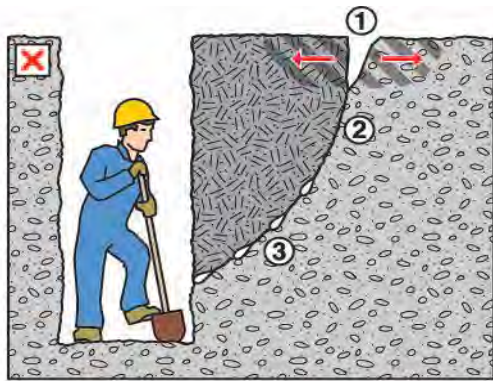

(a) This is a very dangerous situation, requiring ground support. No worker should be in a trench > 1.5m deep unless support has been installed.

1. Area of tension, as wall starts to collapse.
2. Slipping plane.
3. Seepage along the slipping plane further reduces the stability of the wall. Water seeping into the excavation, tension cracks on the surface and bulging side walls are all signs of imminent collapse.

Seepage in trench bottom may not be obvious until the actual collapse.

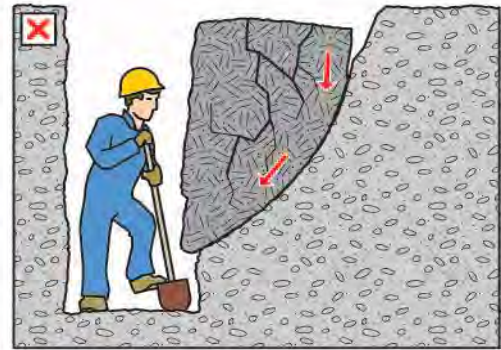

(b) Shear plane failure along the seepage (slippage) plane.

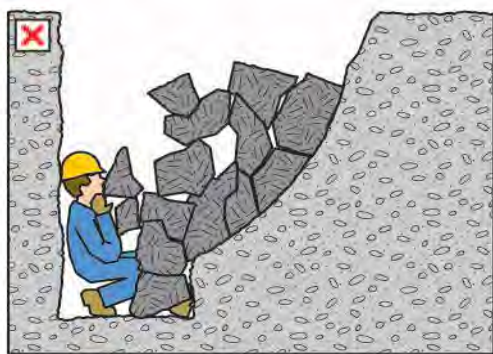

(c) Worker trapped and crushed against the trench wall by the quick collapse.



(d) Worker badly injured and probably smothered after being crushed against the opposite wall by the collapsing ground. The weight of a wedge of sand over a one metre length of trench two metres deep is about three tonnes

Figure 8: Trench collapse and associated ground forces

When planning the work and selecting appropriate excavation methods and control measures, it is important to consider:

- the type and strength of the material to be excavated (e.g. whether the ground is natural and self-supporting or has been previously backfilled)
- the moisture content of the soil
- if the ground is level or sloping
- if groundwater is present
- if there are any discontinuities or faults in the strata
- if there are any other nearby water courses, drains or run-off that might affect the stability of the excavation
- the work area and any access or operational limitations
- the planned height of the excavated face
- if vehicular traffic and/or powered mobile plant will operate near the excavation
- if there will be other construction activity nearby that may cause vibration
- any other loads adjacent to the planned excavation (e.g. buildings, tanks, retaining walls, trees)
- if the need for persons to enter the excavation can be eliminated
- any underground essential services.

The ground conditions will have a significant impact on the selection of an excavation method and the control measures implemented.

Ground conditions

In their natural condition, soils have varying degrees of cohesive strength and frictional resistance. Examples of materials with virtually no cohesive strength are dry sand, saturated sand and gravels with minimum clay content. Ground encountered in excavations can generally be categorised as one of three types:

- hard, compact soil
- soil liable to crack or crumble
- loose or running material.

Of these materials, hard compact soil is the type that can cause the most trouble because the face 'looks good' and this often leads to risks being taken. Loose or running material is often the safest, because the need for safety precautions is obvious from the start.

Soil liable to crack or crumble is doubtful and should be given careful consideration before the treatment to be given is determined. Useful information can often be obtained from local authorities.

Non-cohesive faces can be very hazardous. With the right amount of moisture they can look safe and solid. A little loss of water by evaporation from the face or an increase in water content from rain or other causes can make the soil crumble.

The stability of any excavated face depends on the strength of the soil in the face being greater at all times than the stresses it is subjected to. The following situations all increase soil stresses in an excavated face and may lead to failure under adverse weather conditions, additional load or vibration:

- deep cuts and steep slopes, by removal of the natural side support of the excavated material
- loads on the ground surface near the top of the face, such as excavated material, digging equipment or other construction plant and material
- shock and vibration, which could be caused by pile-driving, blasting, passing loads or vibration producing plant
- water pressure from ground water flow, which fills cracks in the soil, increases horizontal stresses and the possibility of undermining

- saturation of soil, which increases the weight and in some cases the volume of the soil.

The following may reduce soil strength:

- excess water pressure in sandy soil which may cause boils and saturate the soil and increase its plasticity
- dryness of the soil may reduce cohesion in sandy soil and soils high in organic content which then crumble readily
- prolonged stress, may cause plastic deformity (squeezing or flowing)
- prolonged inactivity at an excavation site. An evaluation of the soil should be undertaken before work recommences.

There are three main types of ground collapse control measures that can be used where ground collapse may occur:

- benching and battering
- positive ground support - for example shoring
- shielding – shields do not ensure ground stability but they protect workers inside the shield from ground collapse by preventing the collapsing material from falling onto them.

6.1 Benching and battering

One fairly simple way of controlling the risk of ground collapse is to bench or batter the excavation walls. An excavated slope is safe when the ground is stable. That is, the slope does not flatten when left for a considerable period, there is no movement of material down the slope and the toe of the slope remains in the same place.

If excavation work is planned to be carried out without positive ground support (that is, shoring), the continuing safety of the excavation will depend on the conditions arising during construction. If the conditions during construction are not as expected, or if conditions change during the course of the work (e.g. different soils, heavy rain/flooding) action should be taken immediately to protect workers, other persons and property. Implement appropriate control measures such as temporarily suspending work until the ground is stable or, if necessary, providing positive ground support.

Benching is the creation of a series of steps in the vertical wall of an excavation to reduce the wall height and ensure stability (see Figure 9). Benching is a method of preventing collapse by excavating the sides of an excavation to form one or more horizontal levels or steps with vertical surfaces between levels.

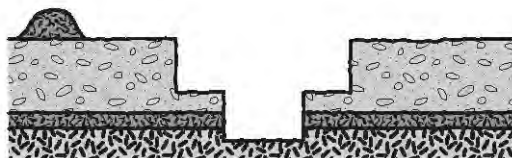

Figure 9: Benching

Battering is where the wall of an excavation is sloped back to a predetermined angle to ensure stability (see Figure 10). Battering prevents ground collapse by cutting the excavated face back to a safe slope. Battering should commence from the bottom of the excavation and in some circumstances it may be appropriate to use a combination of the two methods on an excavation (see Figure 11).



Figure 10: Battering

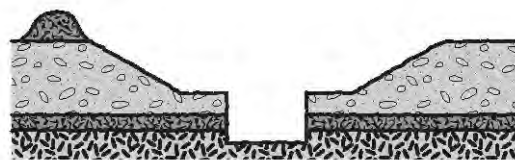

Figure 11: Combination of benching and battering controls

Benching and battering of excavation walls can minimise the risk of soil or rock slipping onto the excavation. Control measures should be designed by a competent person (e.g. geotechnical engineer) and be relative to the soil type, the moisture content of the soil, the planned height of the excavated face and any surcharge loads acting on the excavated face.

It is not necessary to bench or batter the face of excavations which a competent person determines are in stable rock or has assessed that there is no risk of collapse. When benching or battering the walls of an excavation, an angle of repose of 45 degrees should not be exceeded unless designed by a competent person and certified in writing.

Benches should be wide enough to stabilise the slopes and to prevent material from the top falling down to the working area. They should also be sloped to reduce the possibility of water scouring.

The size and type of any earthmoving machinery to be used and any related haul routes should be considered when designing the face slopes and widths of benches.

6.2 Shoring

Shoring is a positive ground support system that can be used when the location or depth of an excavation makes battering and/or benching impracticable. It should always be designed for the specific workplace conditions by a competent person (e.g. an engineer).

Shoring is the provision of support for excavated face(s) to prevent the movement of soil and therefore ground collapse. It is a common method of ground support in trench excavation where unstable ground conditions, such as soft ground or ground liable to be wet during excavation such as sand, silt or soft moist clay are often encountered.

Where ground is not self-supporting and benching or battering are not practical or effective control measures, shoring should be used. Shoring should also be used when there is a risk of a person being buried, struck or trapped by dislodged or falling material which forms the side of, or is adjacent to, the excavation work.

Where such a risk also exists for those installing shoring, other appropriate control measures must be in place to ensure the health and safety of persons entering the excavation.

Shoring the face of an excavation should progress as the excavation work progresses. Where earthmoving machinery is used risk assessment should be used to determine whether any part of the trench may be left unsupported.

The system of work included in the SWMS should ensure workers do not enter any part of the excavation that is not protected. They should not work ahead of the shoring protection if it is being progressively installed.

The basic types of shoring are hydraulically operated metal shoring and timber shoring. The most common shoring used consists of hydraulic jacks and steel struts, walls and sheeting. Sometimes aluminium or timber components are used.

The use of metal shoring has largely replaced timber shoring because of its ability to ensure even distribution of pressure along a trench line and it is easily adapted to various depths and trench widths.

Some of the common types of shoring are:

- hydraulic systems
- steel sheet piling
- steel trench sheeting
- timber systems (e.g. soldier sets)
- precast concrete panels
- ground anchors.

Hydraulic systems

Hydraulic support systems are commonly used to provide temporary or mobile ground support while other ground supports are being installed (see Figure 12).

Ground pressures should be considered prior to installing hydraulic supports. The hydraulic support system should be designed by a competent person in consultation with the geotechnical engineer. The hydraulic capacity of the temporary ground support system must be designed to resist the expected ground pressures and potential for collapse.

Hydraulic support systems may become unreliable if not properly maintained and properly used. Frequent inspections of pressure hoses and rams are necessary to detect abrasion, fatigue or damage such as bent or notched rams.

When a trench has been fully supported the hydraulic support systems should be dismantled to prevent costly damage. The hydraulic supports should be inspected, repaired if necessary and carefully stored prior to re-use.

Further information on hydraulic shoring is available in *AS 5047: Hydraulic shoring and trench lining equipment*.

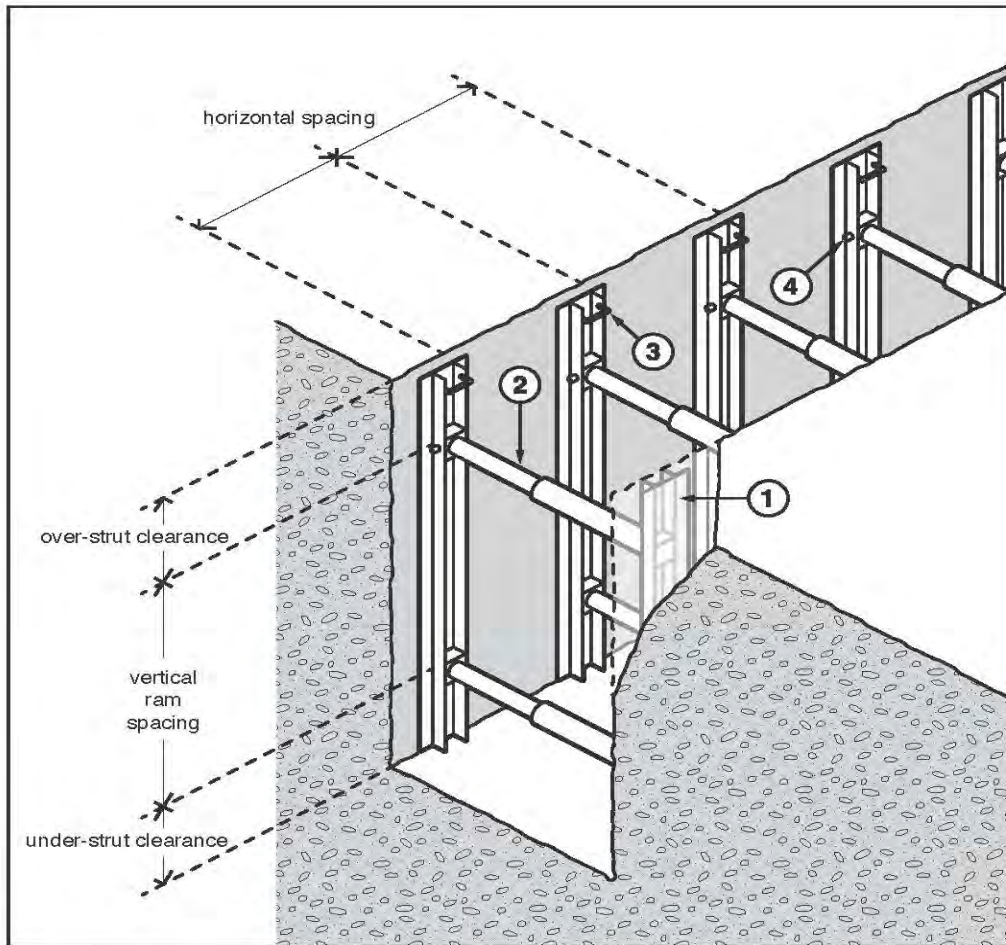

1. Soldier rail
2. Hydraulic soldier strut
3. Lifting/handling point
4. Pin

Figure 12: Hydraulic shoring (soldier set style)

Steel sheet piling

Steel sheet piling is generally used on major excavations such as large building foundations or where large embankments are to be held back and can be installed prior to excavation work commencing. It is also used where an excavation is in close proximity to adjoining buildings (see Figure 13).

Sheet piling may be used when the ground is so unstable that side wall collapse is likely to occur during excavation, for example, in loose and running sand. In such cases, sheet piling should be installed before excavation commences.

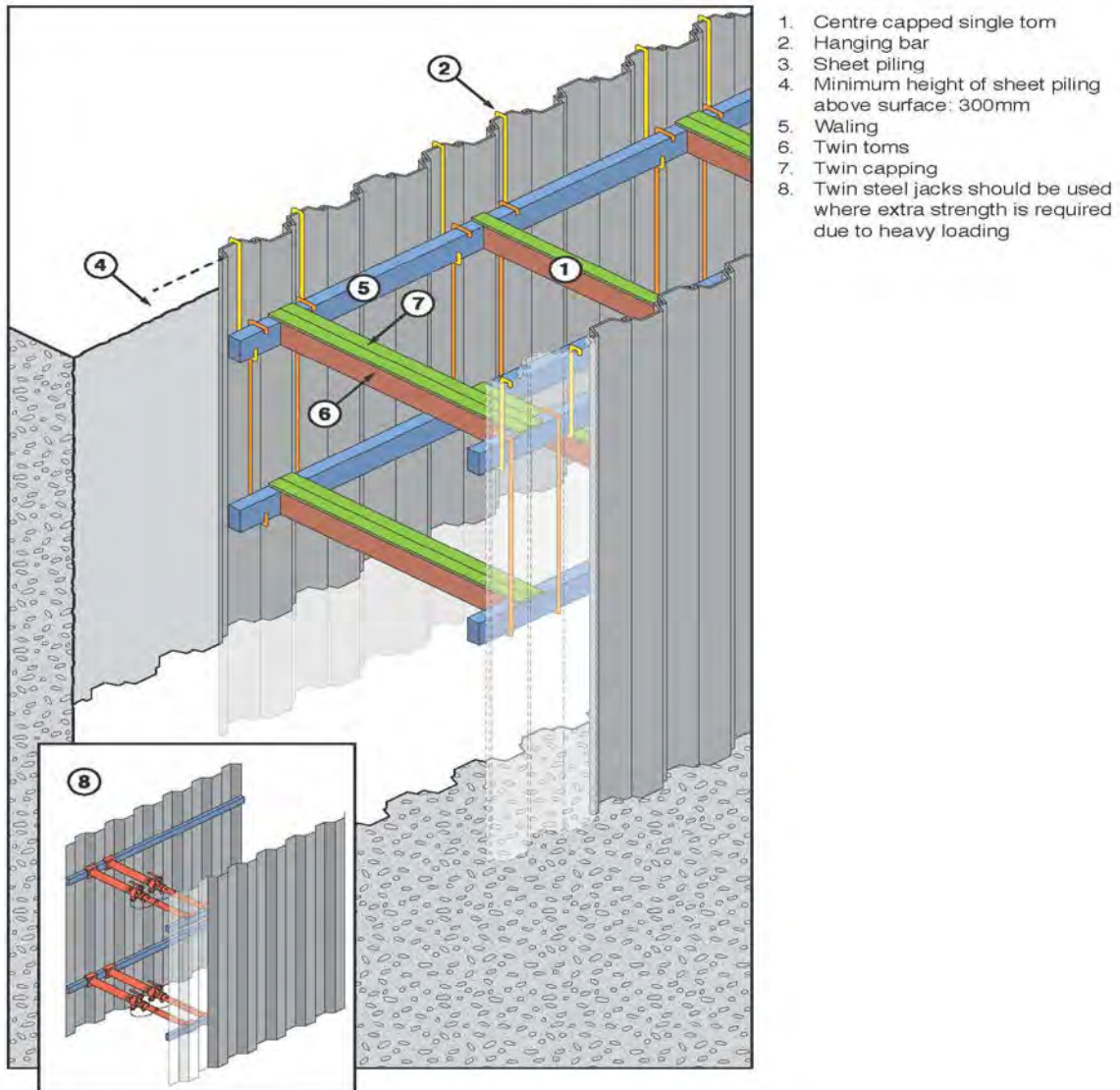

Figure 13: Steel sheet piling

Steel trench sheeting

Other methods of excavation may require the use of steel trench sheeting or shoring. It is positioned and pneumatically driven in to final depth. Toms and walings are placed into position as the soil is excavated. Although timber can be used it is more efficient to use adjustable jacks or struts (see Figure 14).

Steel trench sheeting is lighter weight than normal sheet piling and in some circumstances may be driven by hand-held pneumatic hammers or electrical operated vibrating hammers. The potential for manual handling injuries to occur in this operation is very high, as is the risk of lacerations due to sharp metal protrusions. These risks should be addressed prior to commencement of driving the steel sheet. Any projections on the underside of the anvil of jack hammers should be removed to prevent damage to the driving cap and potential injury to the operator.

During driving operations, if it is likely that workers may be exposed to noise levels in excess of the exposure standard, a method of controlling the noise exposure is required.

Steel shoring and trench lining equipment should be designed by a competent person. Further information on steel shoring can be found in *AS 4744.1: Steel shoring and trench lining – Design*.

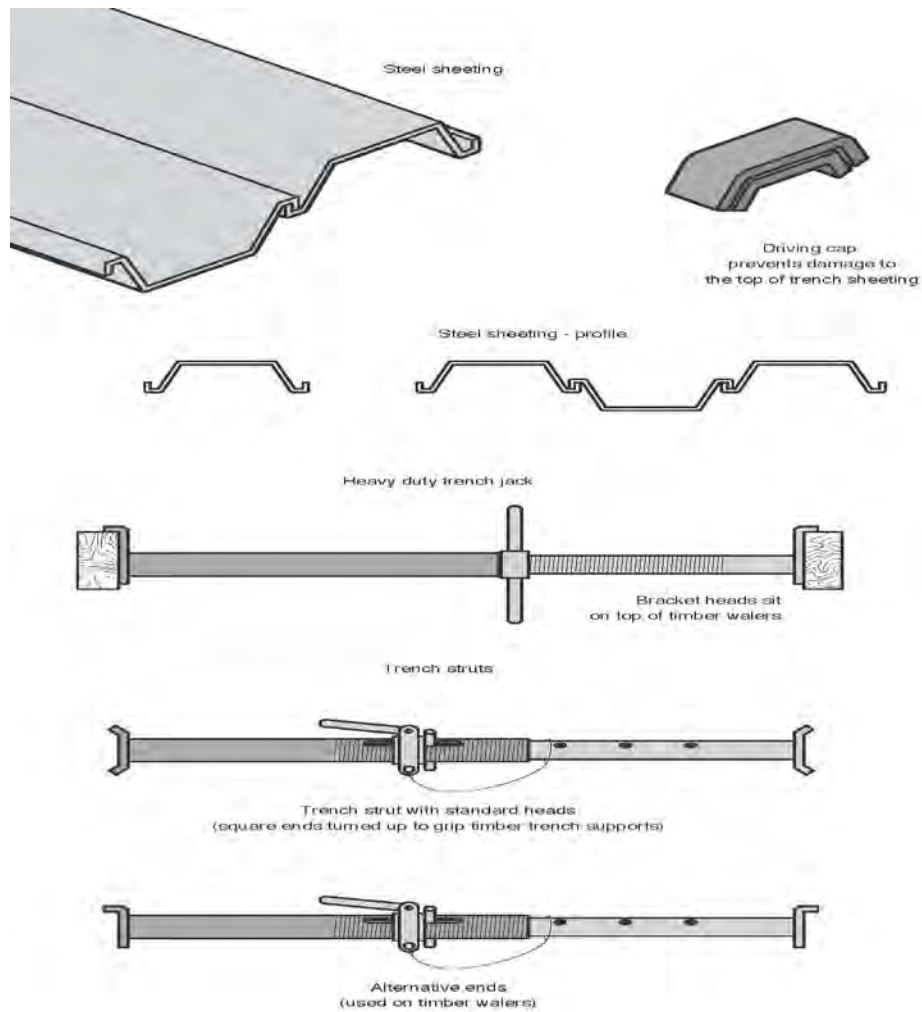
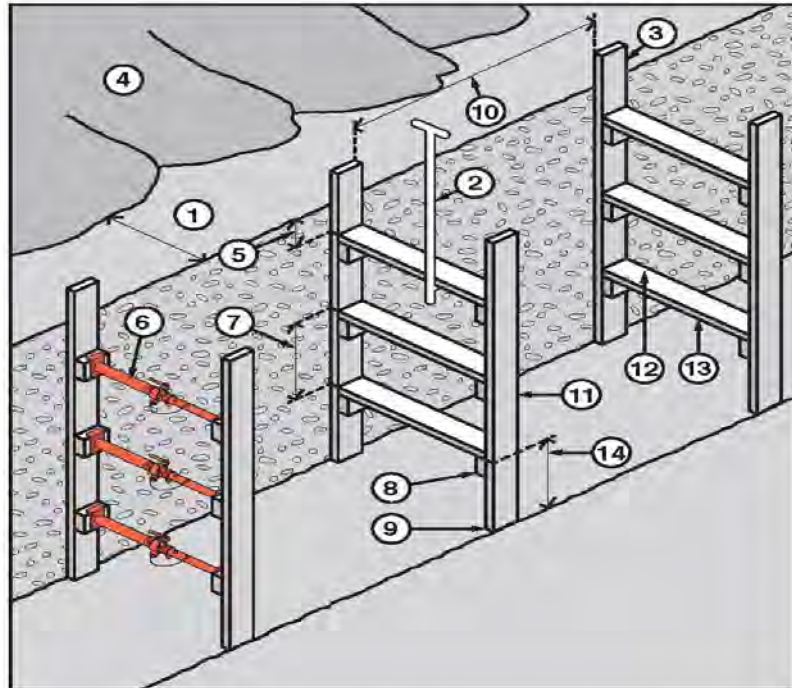

Figure 14: Steel trench sheeting and jacks

Timber soldier sets

The soldier set is a simple form of trench support set which can be formed with steel or timber. This system is mostly used in rock, stiff clays and in other soil types with similar self-supporting properties.

Unlike closed sheeting sets, soldier sets retain the earth where there may be a fault in the embankment. Soldier sets only provide ground support at regular intervals and do not provide positive ground support to the whole excavated face. Open soldier sets are only suitable for use in stable soil types. (see Figure 15).



1. Spoil heap at least 600mm clear of excavation allows access along both sides of the trench top and prevents material from the heap rolling into the trench.
2. Toms placed from surface with special timbering tongs.
3. Soldiers protrude 500mm above the top of the trench.
4. Spoil heap or pile.
5. Top tom no lower than 300mm from the trench top.
6. For added side support, steel jacks may replace timber toms.
7. Maximum spacing of toms no more than 750mm.
8. Cleats securely nailed to soldiers before placing soldiers in trench.
9. Soldier resting securely on trench bottom.
10. Maximum spacing between soldier sets 1.5 metres.
11. Soldier, minimum size 150mm x 38mm.
12. Tom, minimum size 150mm x 38mm.
13. Tom should be long enough to force soldiers firmly against trench sides. To prevent excessive bowing of soldiers against irregular trench sides, wood packing, between the trench wall and the soldier, may be used.
14. Space between the bottom tom and trench floor should be sufficient to allow installation of a pipe – normally, no more than 1000mm.

Figure 15: Timber soldier sets

Closed sheeting

Closed sheeting is where vertical timber or metal members are used to fully cover and support a trench wall and which are in turn supported by other members of a ground support system.

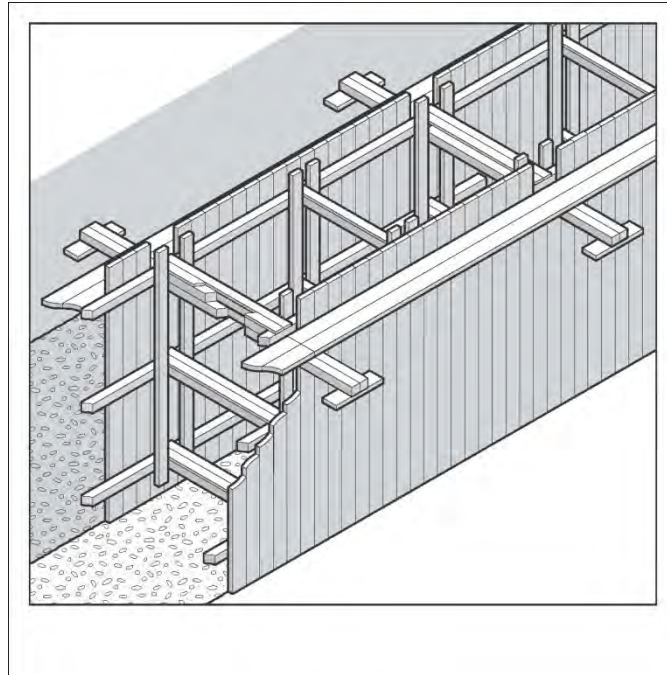

Figure 16: Example of closed sheeting

Side lacing is a form of closed sheeting used primarily to ensure worker safety by preventing soil from slipping by the placement of fill behind timber boards or steel plates (see Figure 17). Side lacing is used in all types of ground, and is particularly useful where long or large diameter pipes are to be installed and in variable ground conditions where steel or timber supports are difficult to install. Side lacing should be firmly wedged into the ground to prevent it from moving when fill is placed against it.

When closed sheeting or side lacing is used to prevent ground collapse, workers should not:

- enter the excavation prior to the installation of the sheeting/lacing
- work inside a trench, outside the protection of sheeting/lacing
- enter the excavation after sheeting/lacing has been removed
- enter an area where there is sheeting/lacing, other than by a ladder.

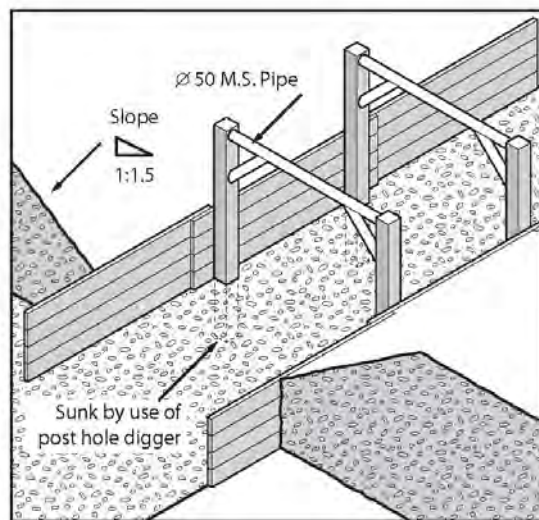

Figure 17: Side lacing in sand trench

Ground anchors

A ground anchor is a tie back to the soil behind the face requiring support and is typically used with steel sheet piling (see Figure 18). Ground anchors may be installed in either granular or clay soils. The design of ground anchors should be carried out by a competent person, for example, a geotechnical engineer.

In granular soil, the anchorage zone is usually a plug of grout located behind the active soil limit line. This plug resists the tension force induced in the stressing cables, due to the shear and cohesion forces developed along its length.

These forces can be due, in part, to the overburden. Removal of soil above installed ground anchors should only be carried out after approval has been received from a competent person.

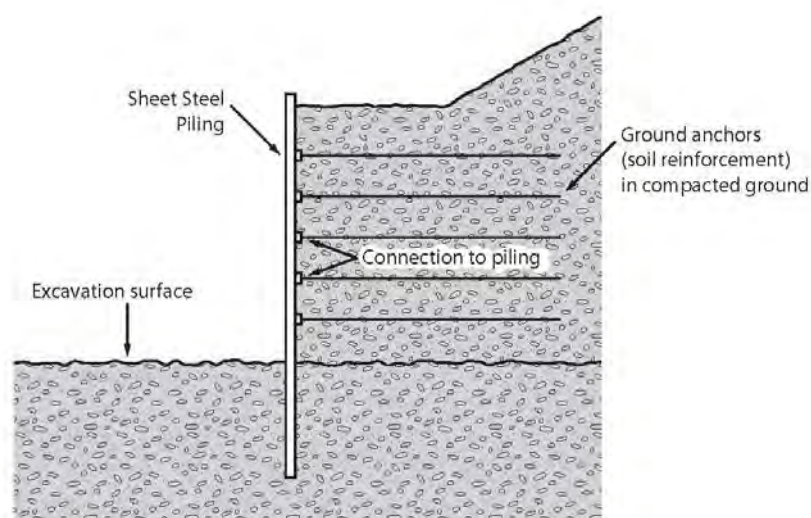

Figure 18: Ground anchors for supporting steel sheet piling

Removal of the soil between the retaining wall and the active soil limit line may cause sheet piling to bend. This bending will release the load in the stressing cable, and render the ground anchor useless and dangerous to workers in the excavation area.

The ground anchor may not develop its original load carrying capacity on replacement of the soil. The anchorage of the stressing cable at the face of the sheet piling may be also dislodged or loosened. This depends on the type of stressing cable and the respective anchoring systems. While the ground anchoring system is operative, periodic checks with hydraulic jacks and pressure gauges are used to assess anchor behaviour over long periods.

6.3 Removal of shoring supports

Shoring and all support systems should be removed in a manner that protects workers from ground collapse, structural collapse or being struck by structural members. Before removal begins, temporary structural members may need to be installed to ensure worker safety.

When removing shoring, the support system should be extracted or dismantled in reverse order to its installation. Persons performing the work in the excavation should not work outside the protection of the ground support system. No part of a ground support system should be removed until the trench is ready for final backfill and compaction.

6.4 Shields and boxes

A shield is a structure, usually manufactured from steel, which is able to withstand the forces imposed by a ground collapse and protect workers within it. Shields can be permanently installed or portable and designed to move along as work progresses.

Many different shield system configurations are available for hire or purchase. Figure 19 shows a typical trench shield.

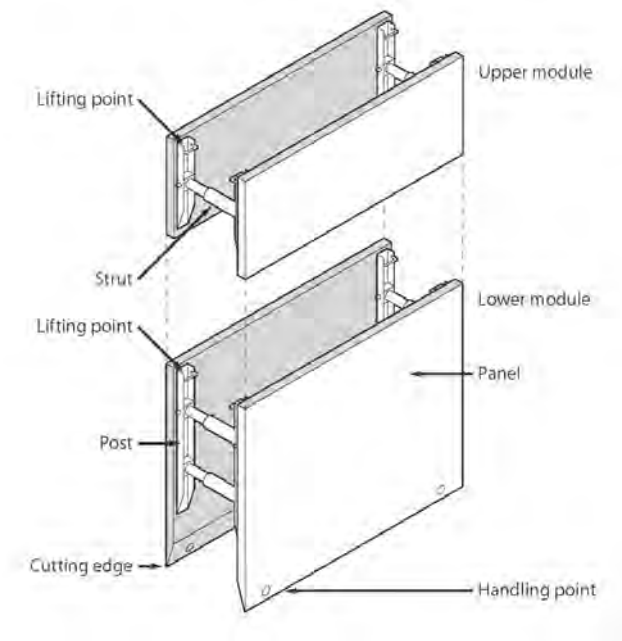

Figure 19: Typical trench shield

Shields and boxes used in trenches are often referred to as trench shields or trench boxes, and are designed and constructed to withstand the earth pressures of particular trench depths and ground types. They incorporate specific lifting points for installation and removal.

Trench shields and boxes differ from shoring as shoring is designed to prevent collapse where shielding and boxes are only designed to protect workers if a collapse occurs.

Trench shields and boxes are useful where other forms of support are not reasonably practicable to install. They are mainly used in open areas where access is available for an excavator or backhoe to lower and raise the boxes or shields into and out of a trench. They are generally not suitable where access is difficult and ground conditions prevent the use of lifting equipment.

Steel boxes for trench work can be light or heavy duty construction depending on the depth of the trench and ground conditions. Trench shields and boxes should be designed by a competent person, for example, an engineer, and be pre-manufactured to job specific dimensions.

Used correctly, shields and boxes can provide a safe work space for workers needing to enter an excavation. Trench shields and boxes should be adequately maintained or they may fail unexpectedly, particularly if they have been abused or misused. The manufacturer's instructions for the installation, use, removal and maintenance of shields and boxes should always be followed.

Trench boxes should not be subjected to loads exceeding those which the system was designed to withstand. Earth pressures are reduced when correct benching and battering practices are used.

Shields and boxes should be stored and transported in accordance with the manufacturer's instructions. Heavy duty equipment may require disassembly for transport.

Boxes should be regularly inspected for damage. They should only be altered or modified with the approval of a competent person.

6.5 Other ground support methods

Support to the face of an excavation can sometimes be effectively provided by the use of chemical stabilisation techniques. These techniques involve injection under pressure of chemical solutions which bind and solidify soil. This method of stabilisation is only possible in porous soils.

6.6 Regular inspection

The condition of soil surrounding excavations can change quickly due to the soil drying out, changes in the water table or water saturation of the soil. The soil condition and the state of shoring, battering and trench walls should be frequently checked by a competent person for signs of earth fretting, slipping, slumping or ground swelling. Where necessary, repair the excavation or strengthen the shoring system from above before allowing work below ground to continue.

APPENDIX A – DEFINITIONS

Barrier	A physical structure which blocks or impedes something.
Barricade	Any object or structure that creates a barrier obstacle to control, block passage or force the flow of traffic in the desired direction
Backfill	Material used for refilling excavations.
Battering	To form the face or side or wall of an excavation to an angle, usually less than the natural angle of repose, to prevent earth slippage.
Bench	A horizontal step cut into the face or side or wall of an excavation to provide horizontal bearing and sliding resistance.
Benching	The horizontal stepping of the face, side, or wall of an excavation.
Closed sheeting	A continuous frame with vertical or horizontal sheathing planks placed side by side to form a continuous retaining wall supported by other members of a support system used to hold up the face of an excavation.
Competent person	A person who has acquired through training, qualification or experience the knowledge and skills to carry out the task.
Earthmoving machinery	Operator controlled mobile plant used to excavate, load, transport, compact or spread earth, overburden, rubble, spoil, aggregate or similar material, but does not include a tractor or industrial lift truck.
Exclusion zone	An area from which all persons are excluded during excavation work.
Face	An exposed sloping or vertical surface resulting from the excavation of material.
Geotechnical Engineer	An engineer whose qualifications are acceptable for membership of the Institution of Engineers, Australia and who has qualifications and experience in soil stability and mechanics and excavation work.
Hoist	An appliance intended for raising or lowering a load or people, and includes an elevating work platform, a mast climbing work platform, personnel and materials hoist, scaffolding hoist and serial hoist but does not include a lift or building maintenance equipment.
Overburden	The surface soil that must be moved away.
Operator protective device	A roll-over protective structure (ROPS), falling object protective structure (FOPS), operator restraining device and seat belt.
Powered mobile plant	Plant that is provided with some form of self-propulsion that is ordinarily under the direct control of an operator.
Safe slope	The steepest slope at which an excavated face is stable against slips and slides, having regard to the qualities of the material in the face, the height of the face, the load above the face and the moisture conditions for the time being existing.
Shaft	A vertical or inclined way or opening from the surface downwards or from any underground working, the dimensions of which (apart from the perimeter) are less than its depth.
Sheet piling	Vertical, close-spaced, or interlocking planks of steel, reinforced concrete or other structural material driven to form a continuous wall ahead of the excavation and supported either by tie-backs into solid ground structural members from within the excavation as the work proceeds.

Shoring	The use of timber, steel or other structural material to support an excavation in order to prevent collapse so that construction can proceed.
Soldier	Vertical upright steel or timber element used for supporting a trench wall.
Strut	Structural member (usually horizontal) in compression resisting thrust or pressure from the face or faces of an excavation.
Tom	Structural member used to hold soldiers against a trench wall or to press walers apart in a close sheeted trench.
Trench	A horizontal or inclined way or opening: <ul style="list-style-type: none"> • the length of which is greater than its width and greater than or equal to its depth; and • that commences at and extends below the surface of the ground; and • that is open to the surface along its length.
Trench box	A structure with four vertical side plates permanently braced apart by bracing designed to resist the pressure from the walls of a trench and capable of being moved as a unit.
Trench shield	A steel or metal structure with two vertical side plates permanently braced apart by cross frames or struts designed to resist the pressure from the walls of a trench and capable of being moved as a unit.
Tunnel	An underground passage or opening that is approximately horizontal and commences at the surface of the ground or an excavation.
Waler	A horizontal steel or timber element used for supporting a trench wall.
Water scouring	An erosion process resulting from the action of the flow of water.
Zone of influence	The volume of soil around the excavation affected by any external load (e.g. vehicles, plant, excavated material).



Workplace Standards

PO Box 56 Rosny Park TAS 7018

Helpline 1300 366 322 (within Tasmania)
(03) 6233 7657 (outside Tasmania)

Fax: (03) 6233 8338

www.worksafe.tas.gov.au